



Air³

Reconfigurable, modular
meeting rooms

orangebox



Product Description

Launched in 2014, Orangebox's award-winning Air³ acoustic pod range can act as a freestanding meeting room, private space, phone booth or touchdown room. The Air³ combines new materials with a wider range of finishes and the most advanced room system on the market, all of which helps make it the world's most complete pod system.

Air³ has been designed as a scalable system, able to work globally. Its internationally patented opening roof system features an advanced fire safety system developed specifically for sprinklered office and other environments.

Interchangeable panels allow you to refresh your Air³ at will, swapping, changing and refreshing colours and fabrics to make it unique. Its combination of high quality glass and soft acoustic panelling delivers both a refined aesthetic and a high level of insulation and speech privacy.

Like all Orangebox pods, Air³ is demountable – so it can be moved, re-positioned or re-used to suit changing needs.

Our range of Air³ pods offer a pleasing variety of small and large private meeting spaces.



Top – AIR-25, **Bottom** – AIR-20



Product Range

Round Pods - Available in UK only

AIR-10
Half round fixed roof



H2250 [H89]
W2785 [W110] D1672 [D66]

AIR-11
Half round opening roof



H2250 [H89]
W2785 [W110] D1672 [D66]

AIR-12
Round fixed roof



H2250 [H89]
W2785 [W110] D2961 [D117]

AIR-13
Round opening roof



H2250 [H89]
W2785 [W110] D2961 [D117]

AIR-14
Lozenge fixed roof

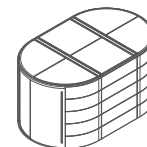

H2250 [H89]
W2785 [W110] D4400 [D173]

AIR-15
Lozenge opening roof

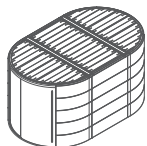

H2250 [H89]
W2785 [W110] D4400 [D173]

AIR-16
3 x 3 soft corner fixed roof

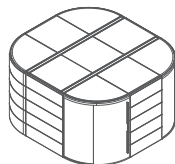

H2250 [H89]
W4090 [W161] D4400 [D173]

AIR-17
3 x 3 soft corner opening roof

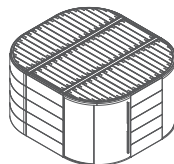

H2250 [H89]
W4090 [W161] D4400 [D173]

Square Pods

AIR-20
Minipod fixed roof only



H2250 [H89]
W2030 [W80] D1507 [D59]

AIR-22
Half square fixed roof

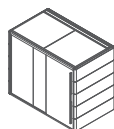

H2250 [H89]
W2785 [W110] D1672 [D66]

AIR-23
Half square opening roof

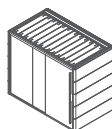

H2250 [H89]
W2785 [W110] D1672 [D66]

AIR-24
Square fixed roof

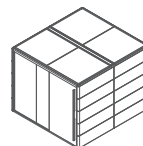

H2250 [H89]
W2785 [W110] D2961 [D117]

AIR-25
Square opening roof

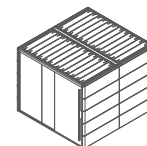

H2250 [H89]
W2785 [W110] D2961 [D117]

AIR-26
Rectangle fixed roof

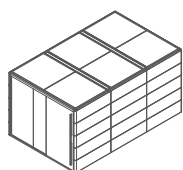

H2250 [H89]
W2785 [W110] D4400 [D173]

AIR-27
Rectangle opening roof

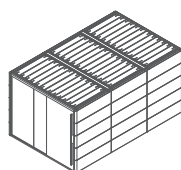

H2250 [H89]
W2785 [W110] D4400 [D173]

AIR-28
3 x 3 large square fixed roof

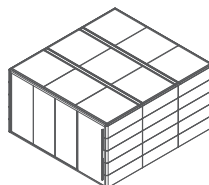

H2250 [H89]
W4090 [W161] D4400 [D173]

AIR-29
3 x 3 large square opening roof

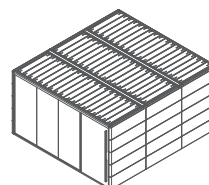

H2250 [H89]
W4090 [W161] D4400 [D173]

*Minimum recommended ceiling height 2550mm to accommodate pod and fan.

mm["]

Product Range

AIR-30
Small table

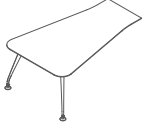

H730 [H29]
W1137 [W45] D1765 [D69]

AIR-31
Medium table

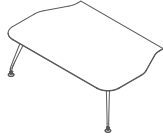

H730 [H29]
W2120 [W83] D1341 [D53]

AIR-32
Large table

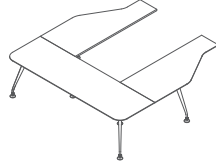

H730 [H29]
W2400 [W94] D2440 [D96]

AIR-33
Long straight table



H730 [H29]
W2608 [W103] D600 [D24]

AIR-34
Right return table

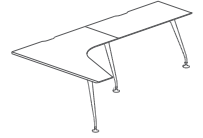

H730 [H29]
W2608 [W103] D1550 [D59]

AIR-35
Short straight table

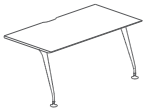

H730 [H29]
W554 [W101] D600 [D24]

MINIPOD TABLE-1
Angle tapered table

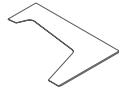

H730 [H29]
W1842 [W73] D1343 [D53]

MINIPOD TABLE-2
Angle tapered table

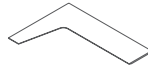

H730 [H29]
W1842 [W73] D1343 [D53]

MINIPOD TABLE-3
Angle tapered table



H730 [H29]
W1344 [W53] D600 [D24]

*Minimum recommended ceiling height 2550mm to accommodate pod and fan.

mm["]



Product Specification – External Structure

Standard Product Description

Glass: Clear Glass as standard.

Hoop Power: Service Hoop Power *3.

Fabric Options: Europost, Blazer & Synergy, Melange Nap, Tonica, Divina 3, Divina Melange and Svensson VY.

Orangebox AIR³ pods with louvered roofs are ETL listed compliant to the UL 1286 Office Furnishings Safety Standard. This includes the entire assembly, not just individual components like the ventilation fans or lighting.

Optional Upcharges

Glass: Frosted Glass (Vinyl Etch).

Hoop Power: Service Hoop 2 UK Power / 2 Data CAT 5 (per pod) or Service Hoop 2 UK Power / 2 Data CAT 6 (per pod).

Fan: Air Circulation Fan.

Door: Door Lock.

Seismic Kit: Available as an upcharge.

Manifestation Options:

Pixel Manifestation Full Screen.

Pixel Manifestation Band.

Pixel Manifestation Visibility Strips.

Barcode Manifestation Full Screen.

Barcode Manifestation Band.

Barcode Manifestation Visibility Strips.

Dots Manifestation Full Screen.

Dots Manifestation Band.

Dots Manifestation Visibility Strips.

Minimum recommended ceiling height 2550mm to accommodate pod and fan.

*Barcode Strips & Band Manifestation run Vertically whilst the Full Screen Barcode runs Horizontally.

Product Certification

Intertek Sustainability Clean Air Product Certification

Clean Air certification provides proof that products have been independently tested and found to conform to VOC standards and to the ANSI/ BIFMA Furniture Emissions Standards. All Orangebox products* have achieved Gold certification, excluding laminate products which achieve a Silver certification.

*With the exception of Fielding Tables.

Product Specification – Internal Furniture

Standard Product Description

Table Top Finishes:

Melamine – Walnut, Grained Oak, Artisan Oak, Beech, Graphite, White or Grey. [30-35]

Table Legs:

RAL 9006 or Black [30-35].

Orangebox AIR³ pods with louvered roofs are ETL listed compliant to the UL 1286 Office Furnishings Safety Standard. This includes the entire assembly, not just individual components like the ventilation fans or lighting.

Optional Upcharges

Table Legs:

Polished, Stone or White. [30-35]

Table Top Power: Power options available. [30-35]

Monitor:

Hoop mounted adjustable Monitor Arms.

Hoop mounted Fixed Monitor Bracket.

Over Upholstery Fixed Monitor Bracket.

Whiteboard: Straight Glass Magnetic Whiteboard or Curved Glass Magnetic Whiteboard.

Minimum recommended ceiling height 2550mm to accommodate pod and fan.

Product Certification

Intertek Sustainability Clean Air Product Certification

Clean Air certification provides proof that products have been independently tested and found to conform to VOC standards and to the ANSI/ BIFMA Furniture Emissions Standards. All Orangebox products* have achieved Gold certification, excluding laminate products which achieve a Silver certification.

*With the exception of Fielding Tables.

Manifestation Options

Please see images for the manifestation locations / dimensions.

All manifestations should be applied to the exterior of the glass.

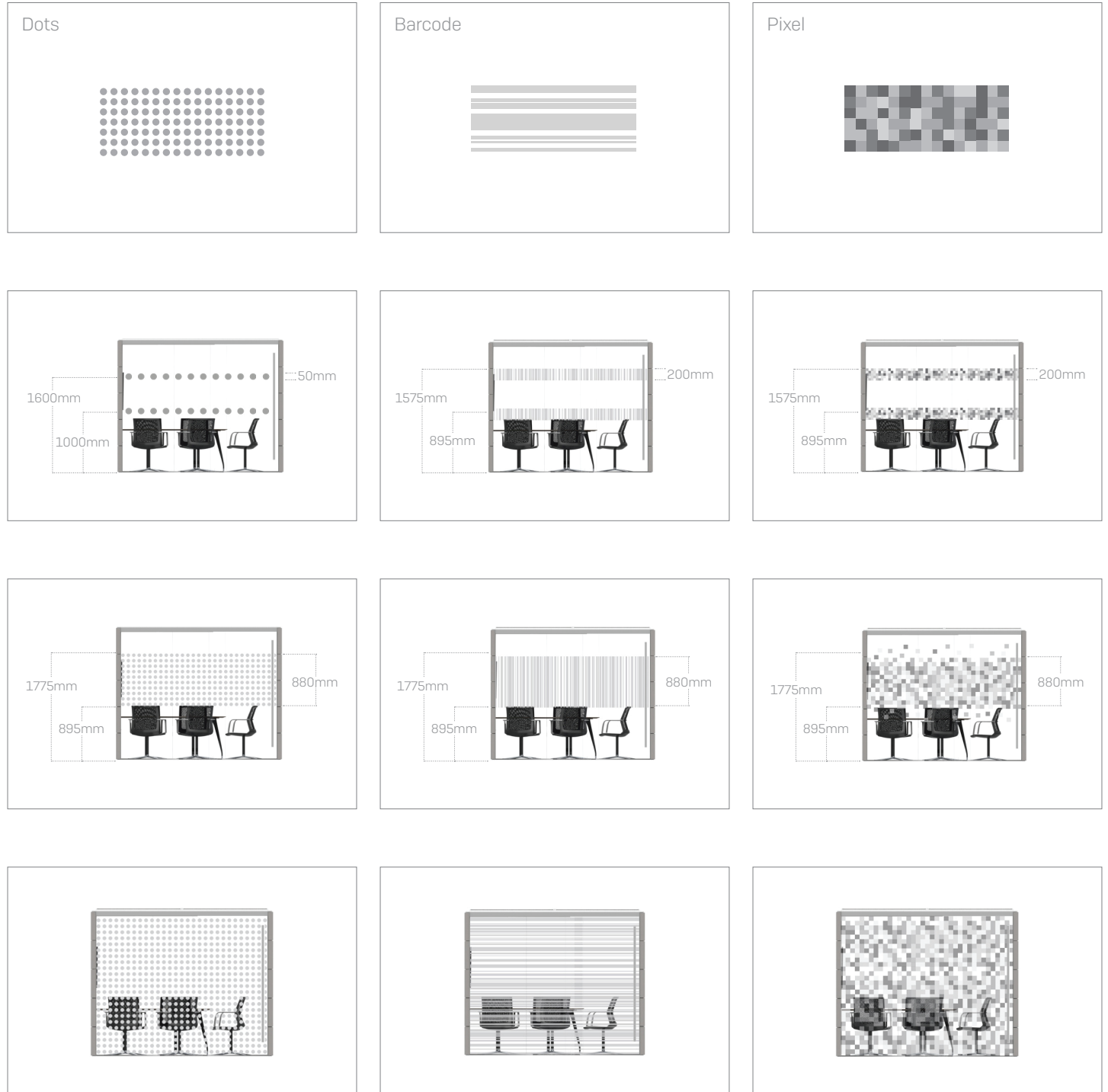

Monitor Bracket Options

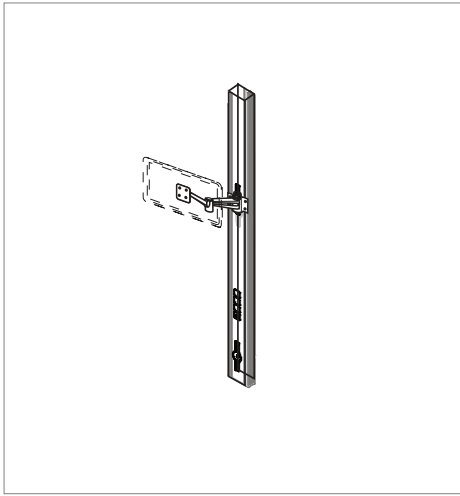

Hoop Mounted Adjustable Monitor Bracket

This is a VESA Mount Only (100mm x 100mm)
Adaptor Available POA. Up to 32". Advised for pods with 1 hoop and small monitors

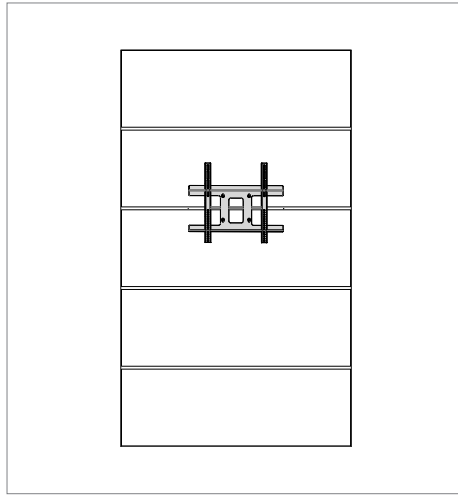

Over Upholstery Fixed Monitor Bracket

Max Weight 25kg, 32-55" Monitors only.
Can be used on all pods with Straight Screens.

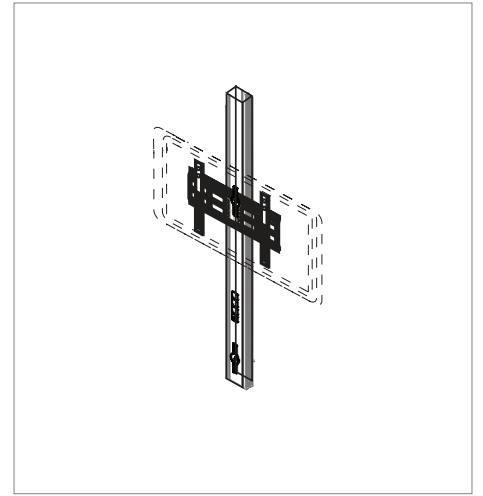

Hoop Mounted Fixed Monitor Bracket

Max Weight 55kg, 32-55" Monitors only.
Advised for use in pods with 1 hoop and large monitors.

Product Finishes

Glass

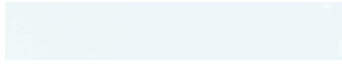

Clear Glass



Frosted Glass

Table Tops — Melamine (30, 31, 32, 33, 34, 35)



Walnut



Grained Oak



Artisan Oak



Beech



Graphite



Grey



White

Table Legs — Metals (30, 31, 32, 33, 34, 35)



RAL 9006



Black



Polished



Stone



White