

**BRIO**  
design Romano Marcato  
2001



A light versatile table that is perfect for bars and restaurants, but that can be easily adapted for use in other contexts, e.g. at the office, in the home to provide extra work space, as an extension to a desk or in tandem with a sofa. Table tops are round or square in various wood types, come in various dimensions and are height adjustable to ensure maximum flexibility.









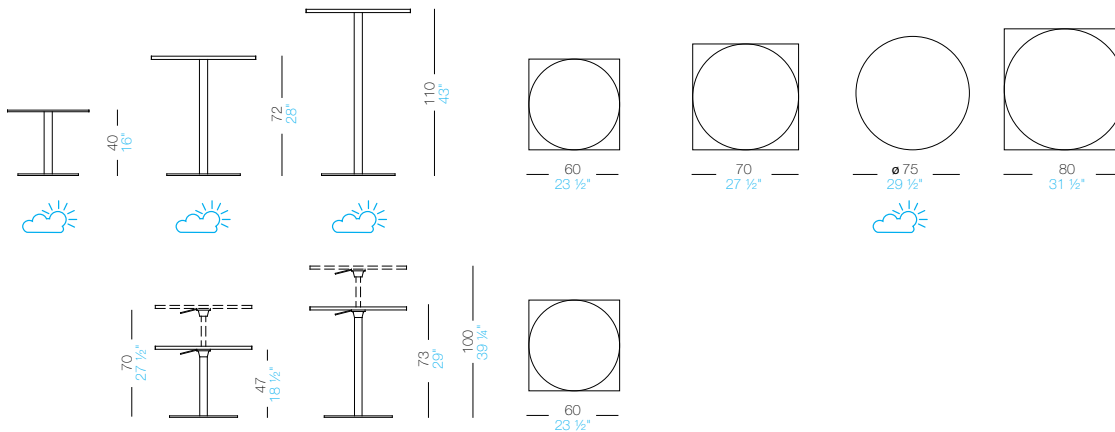

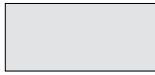











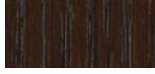
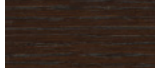

BRIO



Table available in three fixed heights or height adjustable with either round or square tops in several sizes and finishes. The base covered with a stainless steel sheet with "linen fabric" pattern and felt underneath. Leg in mat chromed steel. The table with fix height is also available with powder coated base and column.

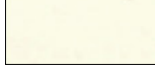

base		top		top ø75			
	stainless steel linen-pattern		white laminate		metal white lacquered		black 
	powder coated: black 		white HPL		metal black lacquered		white 
	powder coated: white 		blanched oak HPL		blanched oak		
	leg mat chromed		oak dark walnut HPL		oak stained dark-walnut		
	powder coated: black 		black fenix HPL		black open pore		
	powder coated: white 		white fenix HPL		serigraphed glass (Ø 60 e 60x60 cm)		
			white lacquered				

## use and maintenance instructions

Clean all parts in wood, leather, fabric and metal with a damp cloth or a diluted neutral cleaner. Do not use cleaners with alcohol, bleach, solvent or abrasive products. Any liquid spill on the product must be wiped up immediately. When lifting or moving the product, hold it on the structure and not under the seat. The product should not be subjected to unbalanced weights, as it is designed for a proper rest on the foothold (on four legs or on the base). Our company relieves from any responsibility in case of damage caused to fragile floors. Avoid any improper use of the product: do not step on the product, on the footrest or on the armrests. Avoid any movements that could compromise the proper functionality of the product or the safety of the users. Wood and leather, being natural materials, could be easily damaged. Small impurities or imperfections are within quality standard range. Do not expose the product to weather conditions or atmospheric agents, nor to heat sources over 45°C. Also products for outdoor use could be afflicted by atmospheric agents. The product could undergo possible exterior changes due to particular exposure to heat, humidity and saltiness. An appropriate and frequent maintenance and cleaning of the product enhances its durability. The product could change colour and shade, if exposed to direct sunlight. Maintenance has to be carried out by experienced staff. Dispose of the package only after assembling the product, in order to avoid the loss of ironmongery and components. Once the product has been dismantled, the product itself or its components must be given to the public garbage disposal system, according to the legislation in force.