

ADD 

Francesco Rota | 2014





# ADD

Francesco Rota | 2014

Nature is a system of endless scenarios. It grows in spring, rests in winter, starts germinating again and arranges and re-arranges the line on the horizon every time. The ADD seating system, an international success, follows the same rhythms and, with the same versatility, also accompanies the pleasure of spending time together outdoors. The primary element, the seed that gives life to everything, is an elegant chair with aluminium base supports, which can be added to in order to become a modular sofa with removable covers. Woods, cornfields, the perspectives of modern architecture spring to mind. An endless ensemble.





Classic mini

---



Two seater

---



Three seater

---



Vis-à-vis — small

---

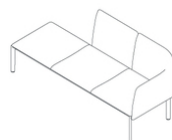

Classic

---



Classic mini — double

---

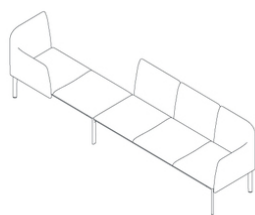

Vis-à-vis — big

---



Side by side

---

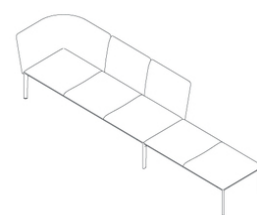

Open

---

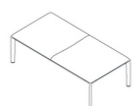

Bench two seater

---

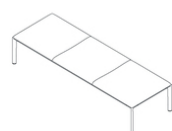

Bench three seater

---

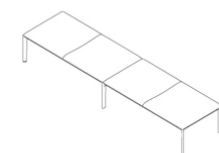

Bench four seater

---

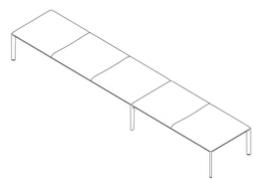

Bench five seater

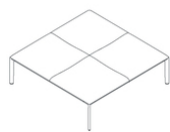

Square bench

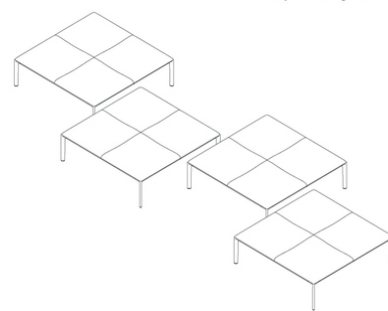

Square bench system



L\_shape - 1



L\_shape - 2

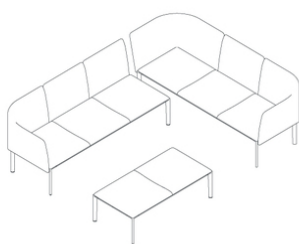

L\_shape - 3

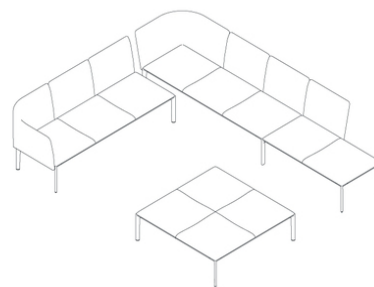

L\_shape - 4

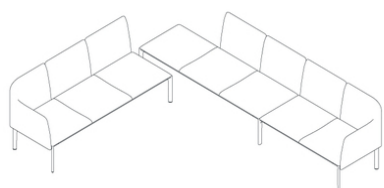

L\_shape - 5

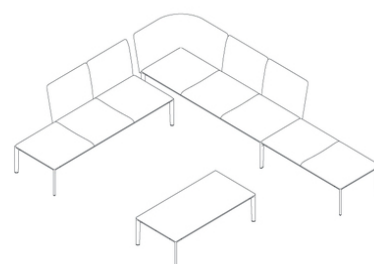

L\_shape - 6

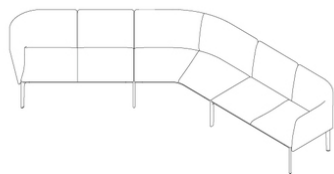

V\_shape in

---

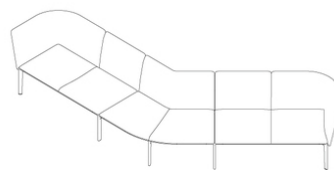

V\_shape out

---

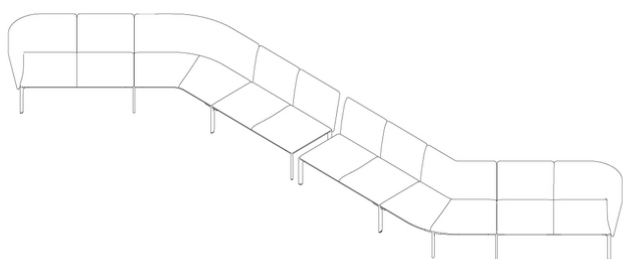

S\_shape - 1

---

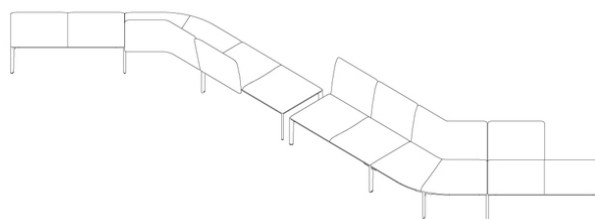

S\_shape - 2

---

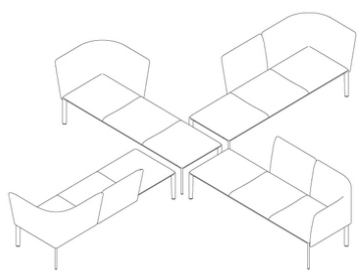

X\_shape

---

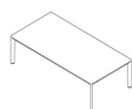

Two

---

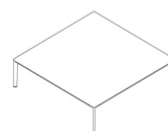

Four

---



Francesco Rota | 2014

Modular seating system with aluminium frame polyester powder coated with webbed elastic support. Two types of recycled die-cast aluminium legs, one for corners and another to connect frames for larger configurations. Each leg type is available in two heights. Backrests can be fixed to the frame in several positions by using pre-drilled holes. Cushions and backrests in moulded fire-retardant polyurethane foam with protective water-resistant and breathable fabric layer and finished with UV stable outdoor fabric. Tops in HPL Fenix® 10 mm. All metal parts are powder coated. Water-resistant protective covers are available.

TEST EN 1728:2012 AC:2013 6.17 - EN 16139:2013 - L2 extreme

legs



seat frames

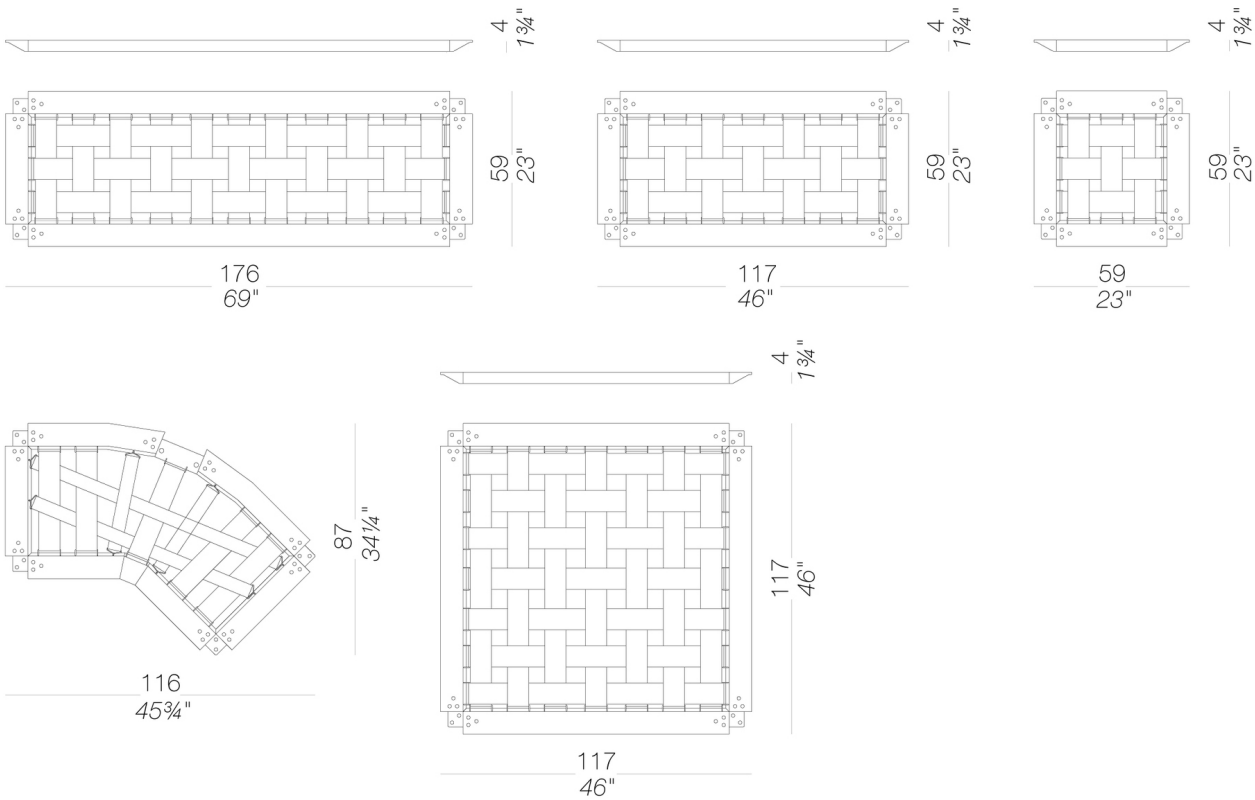

# ADD

Francesco Rota | 2014

## cushions

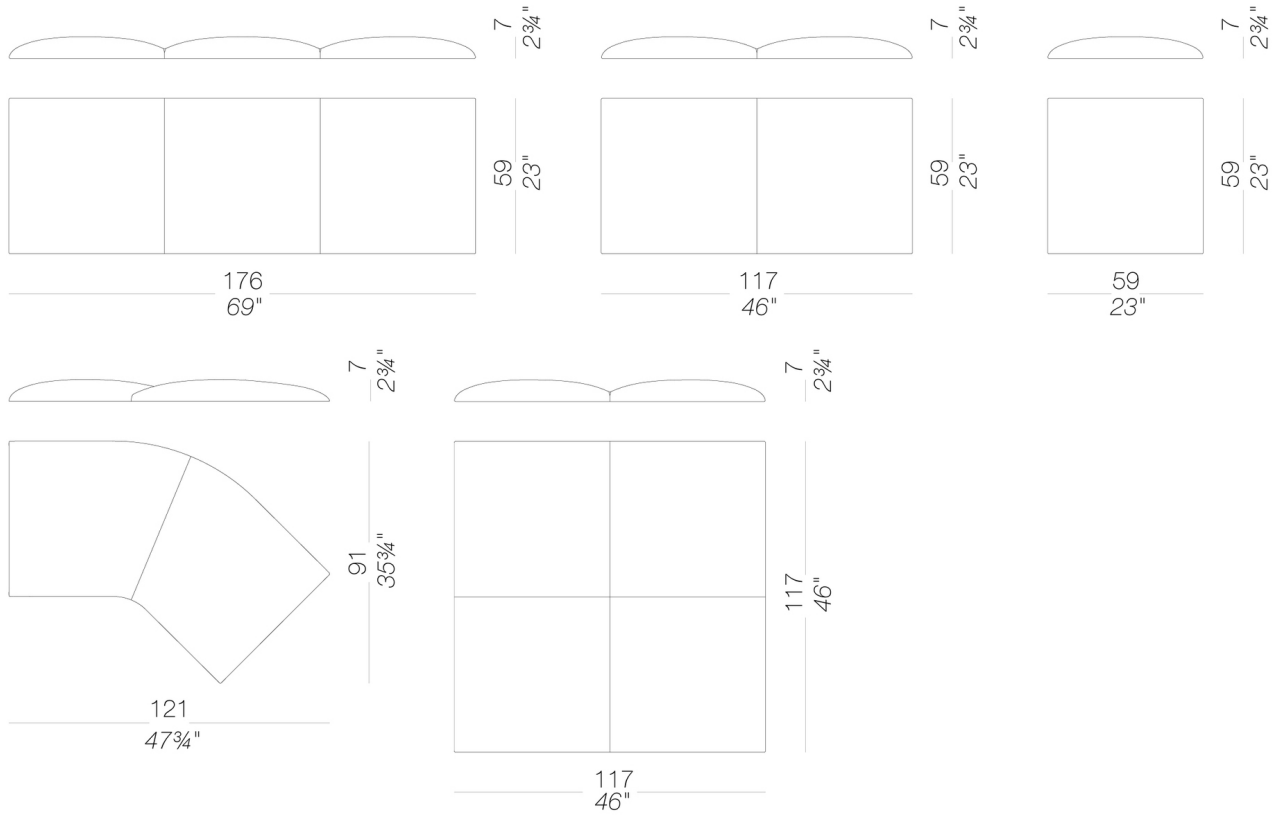

## backs

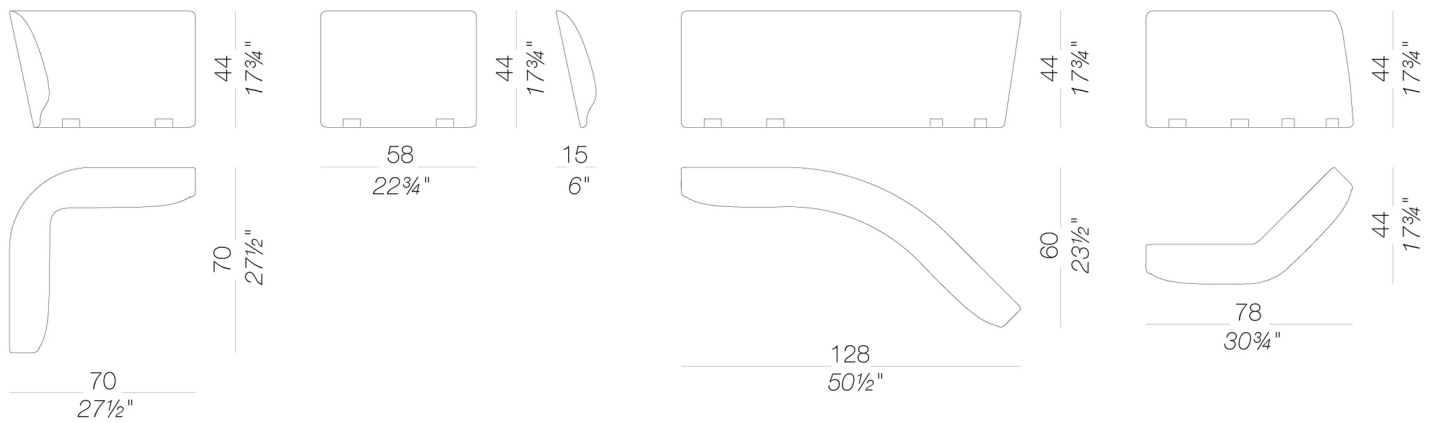

# ADD

Francesco Rota | 2014

## table frames

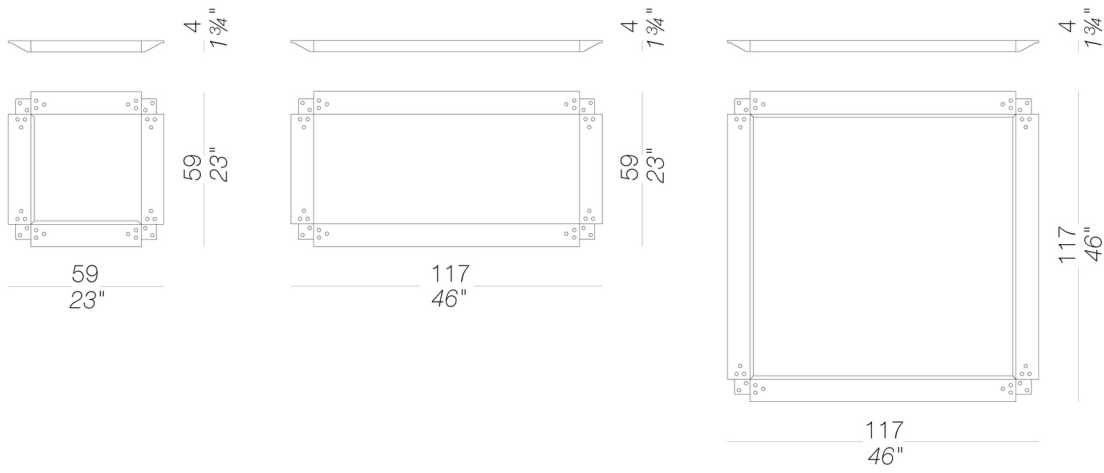

## table tops

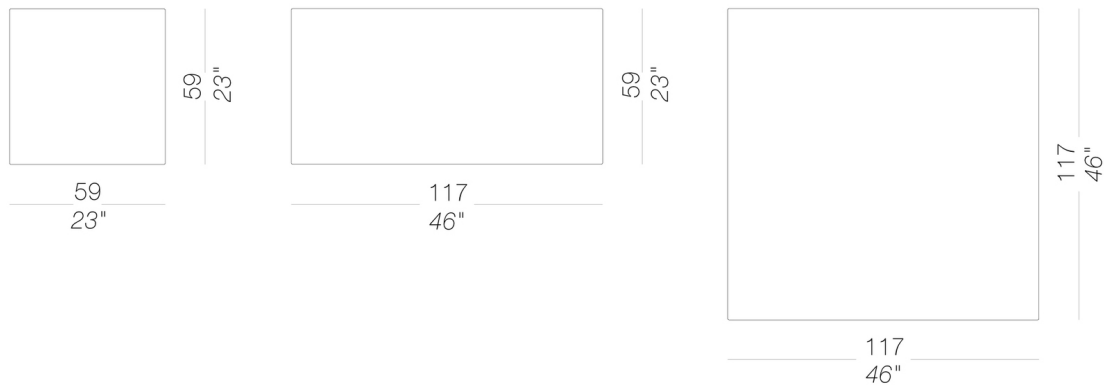

## low tables

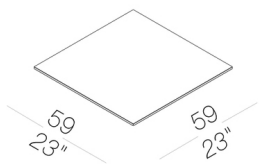



## frame



powder coating  
black  
1 Colors

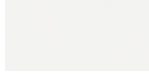

powder coating  
white  
1 Colors

## top



HPL 10 mm  
black HPL fenix  
1 Colors

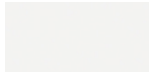

HPL 10 mm  
white HPL fenix  
1 Colors

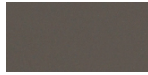

HPL 10 mm  
HPL fenix grigio  
Londra  
1 Colors



HPL 10 mm  
HPL fenix rosso  
Jaipur  
1 Colors

## upholstery

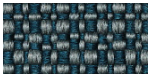

fabric  
Iris  
24 Colors



fabric  
Lapalma Smart  
18 Colors



fabric  
Nattè  
23 Colors

### consult the folder of materials for the range of colors and fabrics

#### use and maintenance instructions

Plastic materials, even if intended for outdoor use, may still be attacked over time by particular atmospheric pollutants (e.g. acid rain, high concentration of PM10, nitrogen oxides, hydrocarbons, etc.). Any changes in the surface and in colours may therefore occur under particular conditions of exposure and cannot be considered grounds for any claims.

Do not use detergents containing bleach, hydrochloric acid or products containing chloride on any metal parts. Salt, limescale or acid (from coffee, wine, orange juice, tomato juice, lemon, etc.) may discolour stainless steel parts if they are not promptly cleaned. Products or parts made of stainless steel used near the sea or in interior fittings of swimming pools require more frequent cleaning to remove chloride deposits and prevent corrosion and chemical attack of the external surface. Stains on stainless steel surfaces must be promptly cleaned. If left for a long time they can become permanent.

Outdoor fabrics are lined unglued, therefore any creasing in the upholstery is an inevitable consequence of use and cannot be considered grounds for any claims. To prolong the life of the product, clean the surfaces regularly, dry them with a clean cloth and remove any stagnant water, especially if exposed in locations with a high level of humidity or a marine climate.

When not in use, we recommend storing in sheltered places and covering with waterproof protection. In this case, it is advisable to remove the cover and ventilate the product frequently and regularly to avoid the onset of any mould or stains due to damp.

THE WARRANTY WILL NOT COVER DEFECTS OR IMPERFECTIONS RESULTING FROM THE PASSAGE OF TIME OR TO WEAR AND TEAR DUE TO THE NORMAL USE OF THE PRODUCT.