

ORI

Romano Marcato | 2020



ORI

Romano Marcato | 2020

Openness, energy and us finally together. ORI, the beautiful new table by Romano Marcato, celebrates a return to the fluid and dynamic pace of life. Every place, whether a home, café, lounge, museum or library, welcomes our creativity. And everywhere, ORI transforms the need for connection into an original and contemporary graphic detail. The aesthetic appeal of its line is enhanced by the table legs, which hide cables and sockets in a secret gap created where the wood and metal are joined. It comes in two heights, 108 cm and 74 cm. Combined with the amazing Lapalma collection of stools and chairs, this large table, with a wood or Fenix top available in a rectangular, square or round version, instantly reveals its genuine, practical and elegant character. As you get closer, you can feel that serenity arising from the perfect blend of nature and technology.



ORI

Romano Marcato | 2020

System of tables in two heights with legs made of bent powder coated metal and solid ash. These allows the cable management. Tops in MDF veneered in blanch oak, or black stained open pore or HPL Fenix®. Thanks to existing holes, the legs can be assembled in different positions, thus linking more tops for multiple solutions of realization. Also available a top access with a tray in bent powder coated metal for cable management.

legs H74

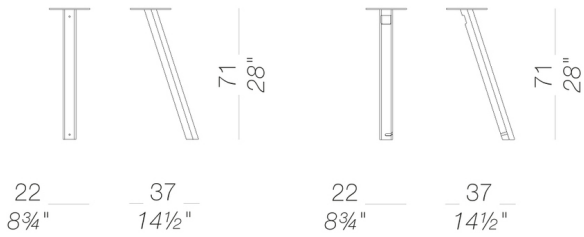

legs H108

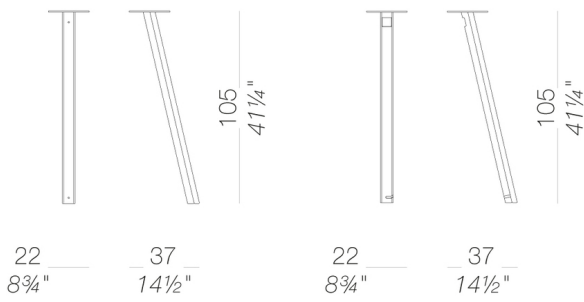

standard tops

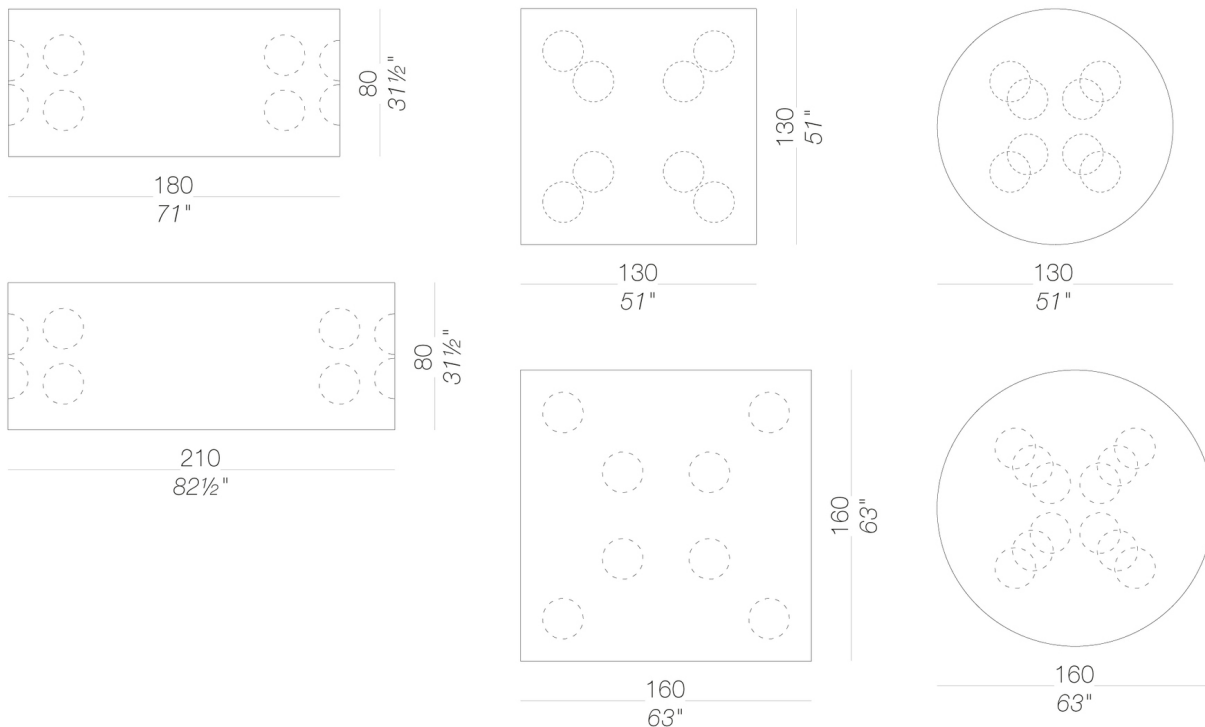

ORI

Romano Marcato | 2020

tops for cable management

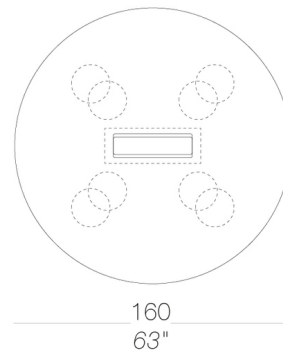
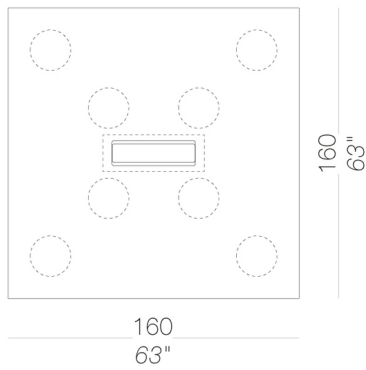
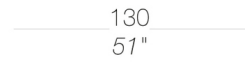
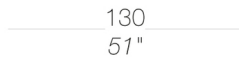
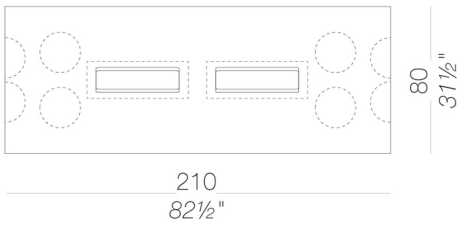
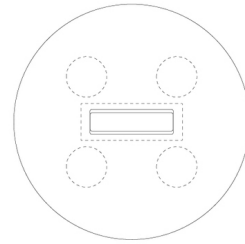
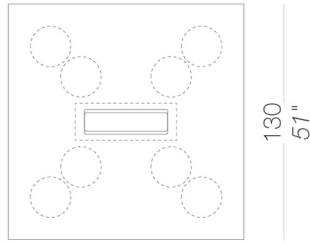
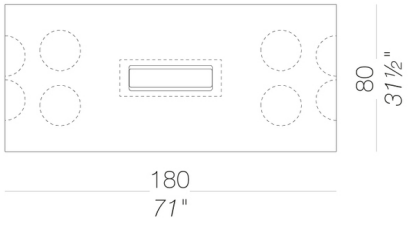

ORI

Romano Marcato | 2020

frame



powder coating
black
1 Colors

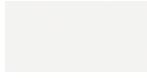

powder coating
white
1 Colors



wood
blached oak
1 Colors

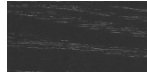

wood
black open pore
1 Colors

top



wood
blached oak
1 Colors

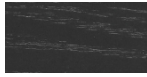

wood
black open pore
1 Colors



laminare
fenix 9/10
2 Colors

consult the portfolio for the range of colors, fabrics, eco-leather, soft-leather.

use and maintenance instructions

Clean all parts in wood, leather, fabric and metal with a damp cloth or a diluted neutral cleaner. Do not use cleaners with alcohol, bleach, solvent or abrasive products. Any liquid spilt on the product must be wiped up immediately. When lifting or moving the product, hold it on the structure and not under the seat. The product should not be subjected to unbalanced weights, as it is designed for a proper rest on the foothold (on four legs or on the base). Our company relieves from any responsibility in case of damage caused to fragile floors. Avoid any improper use of the product: do not step on the product, on the footrest or on the armrests. Avoid any movements that could compromise the proper functionality of the product or the safety of the users. Wood and leather, being natural materials, could be easily damaged. Small impurities or imperfections are within quality standard range. Do not expose the product to weather conditions or atmospheric agents, nor to heat sources over 40°C. Also products for outdoor use could be afflicted by atmospheric agents. The product could undergo possible exterior changes due to particular exposure to heat, humidity and saltiness. An appropriate and frequent maintenance and cleaning of the product enhances its durability. The product could change colour and shade, if exposed to direct sunlight. Maintenance has to be carried out by experienced staff. Dispose of the package only after assembling the product, in order to avoid the loss of ironmongery and components. Once the product has been dismantled, the product itself or its components must be given to the public garbage disposal system, according to the legislation in force.