

adeco.ch

Office | Presentation





1



2



3



4



5

- 1 wallstreet, LW, 100 x 185 x 21
- 2 wallstreet, L, 50 x 185 x 21
- 3 wallstreet room L, 50 x 207 x 35
- 4 o + c system leaflet stand, 101 x 147.5 x 36
- 5 wallstreet, flip-chart, 78 x 108, h 183-213





1



2



3

- 1 wallstreet, flip-chart, projection board, whiteboard, frame
- 2 wallstreet, fantasTisch, 100 x 160 x 160, frame
- 3 wallstreet, room, 50 x 207 x 35

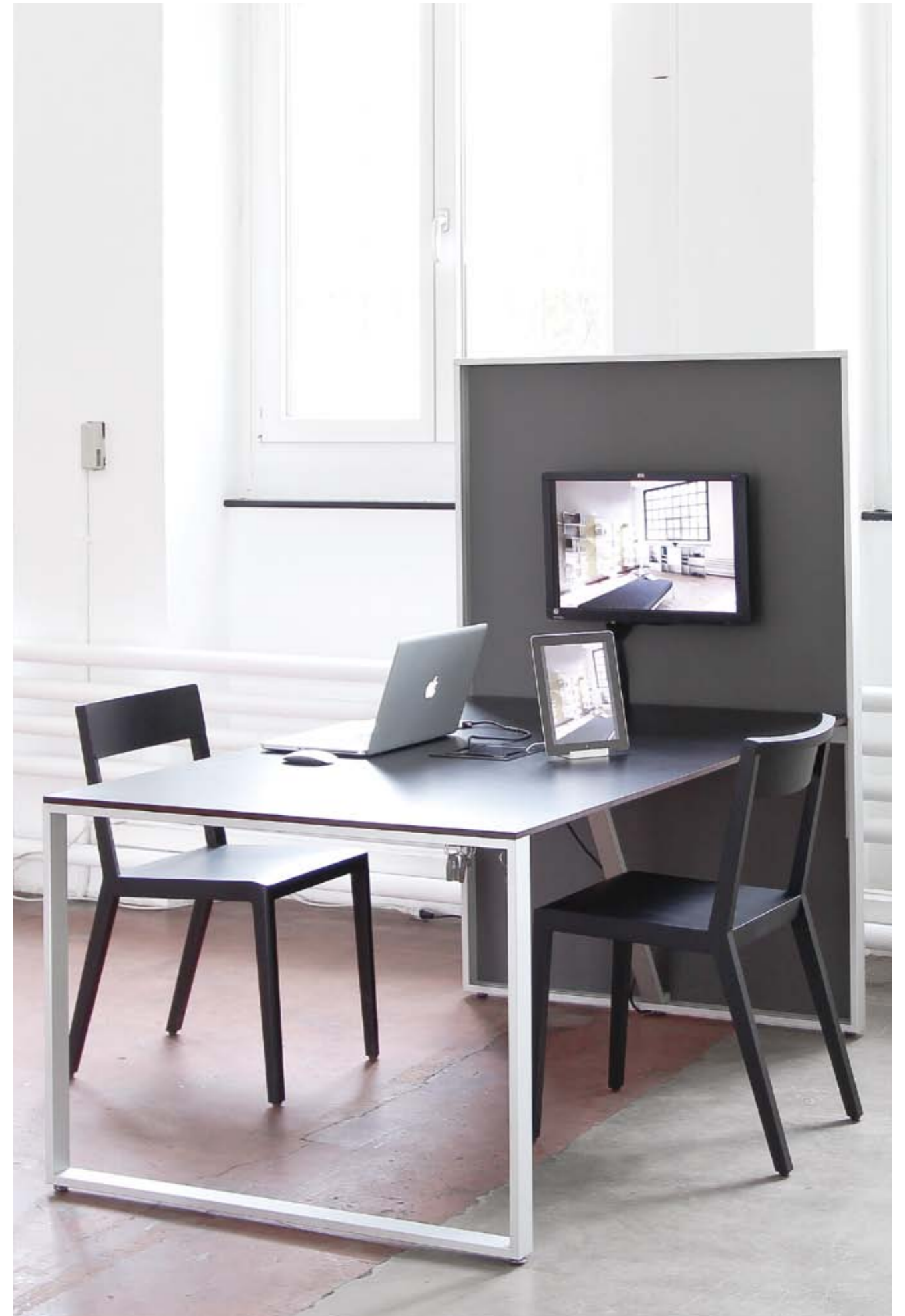

Project Area





- 1 o + c system, exposition, 150 x 192 x 35
- 2 o + c system, mobile whiteboard, 150 x 192 x 56
- 3 wallstreet, flip-chart, 78 x 108, h 183-213
- 4 wallstreet, multimedia table, 50 x 35-45, h 105-135



wallstreet

design greutmann bolzern





1



2



3



4

Wandschiene und einhängbarer Basisrahmen aus eloxiertem Aluminium sind Kernstück des Programms. Verschiedene Ablage- und Boxenmodule bilden ein Baukastensystem im Rahmen.

Core pieces are easy mountable wall rail and frame of anodized aluminium. The building block system includes various storage and box modules.

Rail et cadre en aluminium anodisé forment la partie essentielle du programme. Le système modulaire comprend des étagères et des caissons de différentes dimensions.

1+2 wallstreet LW, 100 x 185 x 35, p.38-39

3 wallstreet room, 50 x 207 x 35, p.38-39

4 wallstreet room, 50 x 207 x 35, p.38-39





wallstreet and acousticpearls



wallstreet, time to change

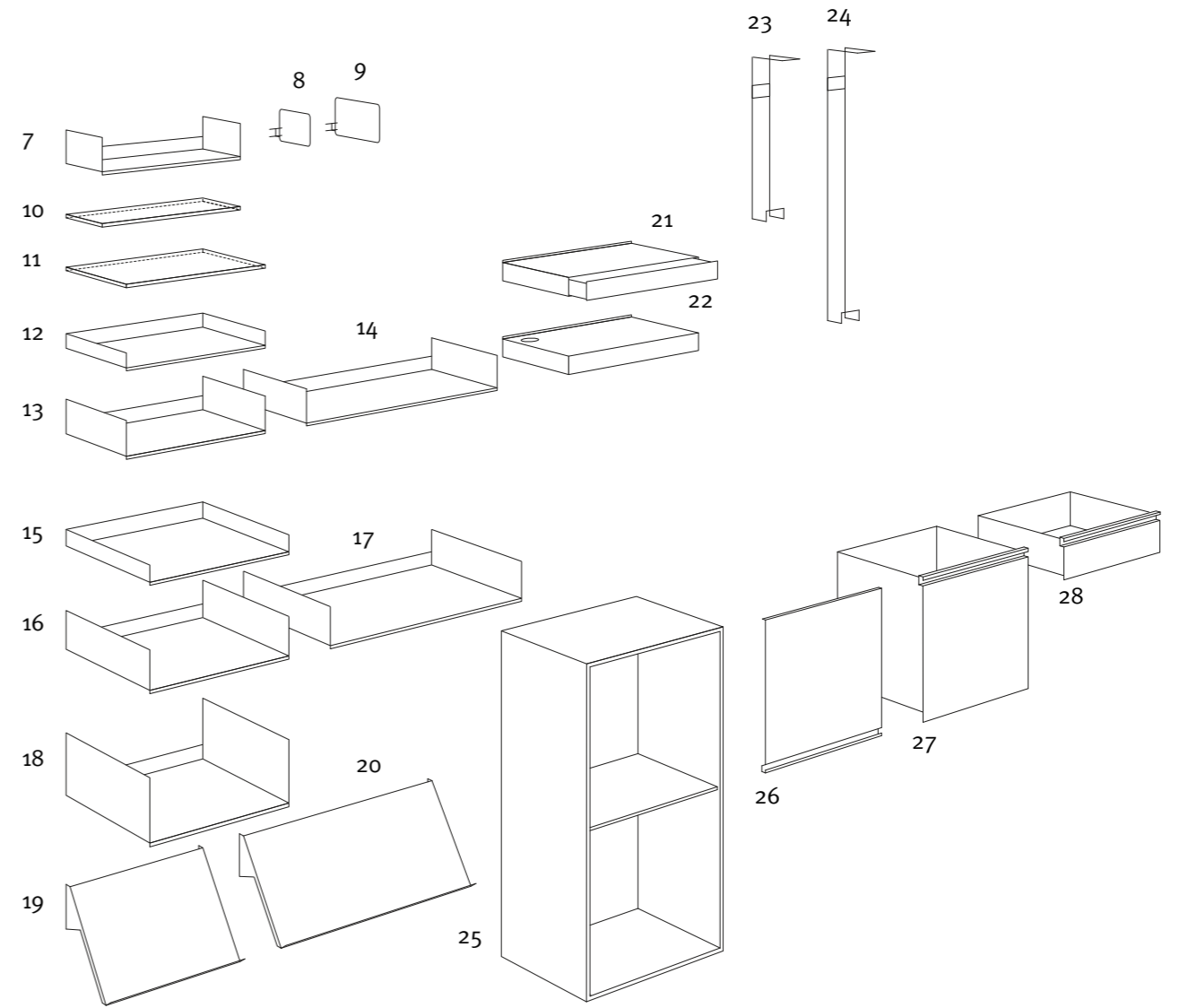
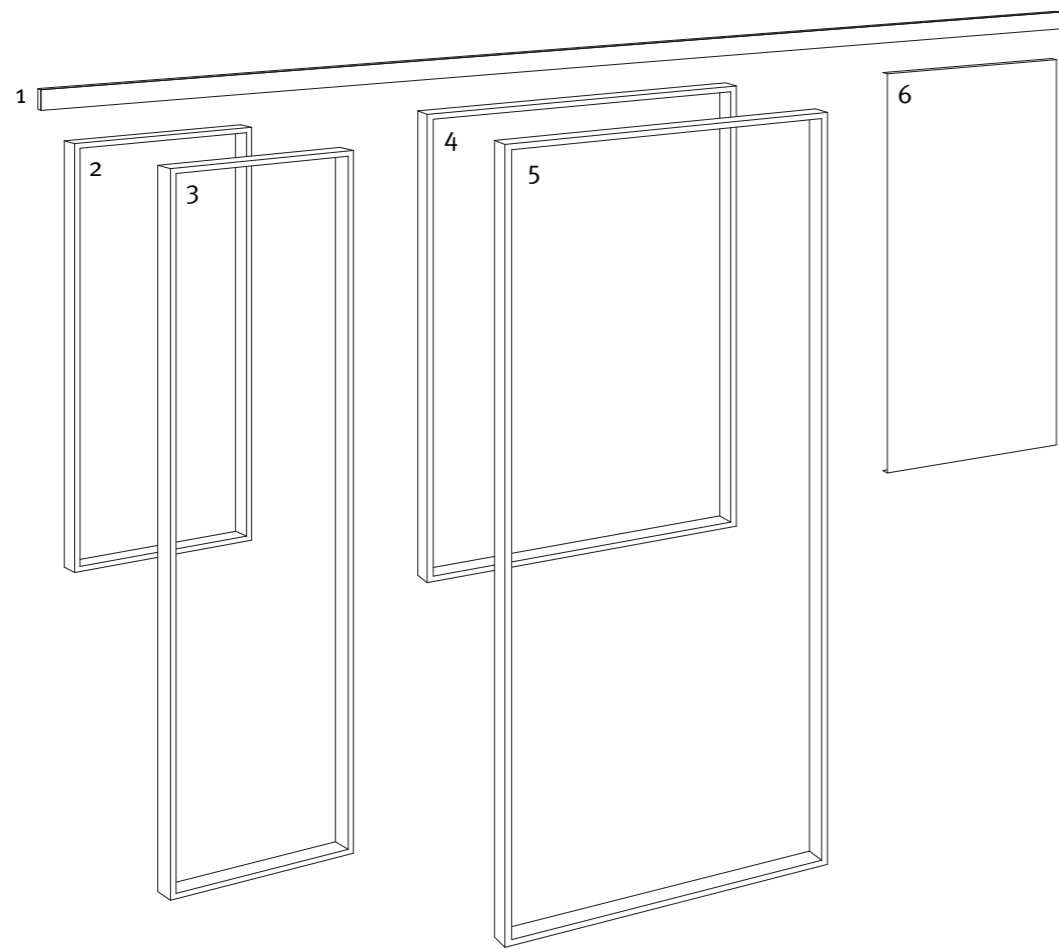

- 1 wallstreet rail 50 | 100 | 200 | 300 cm
- 2 wallstreet S 50 x 120 x 5
- 3 wallstreet L 50 x 185 x 5
- 4 wallstreet SW 100 x 120 x 5
- 5 wallstreet LW 100 x 185 x 5
- 6 wallstreet room transparent | opal | whiteboard | craie | alucubond



- 7 CD 46 x 11.5 x 15
- 8 book-end S 0,6 x 12 x 14
- 9 book-end L 0,6 x 15 x 23
- 10 glass S 46 x 0,6 x 15
- 11 glass L 46 x 0,6 x 25
- 12 ST 46 x 5 x 25
- 13 SM 46 x 11,5 x 25
- 14 SMW 96 x 11.5 x 25
- 15 LT 46 x 5 x 35
- 16 LM 46 x 11.5 x 35
- 17 LMW 96 x 11.5 x 35
- 18 LH 46 x 17 x 35

- 19 brochure 46 x 35 x 2.5
- 20 brochure W 96 x 35 x 2.5
- 21 mini 46 x 8 x 35
- 22 Hifi-box 46 x 8 x 35
- 23 coat rack S 6 x 50 x 18
- 24 coat rack L 6 x 90 x 18
- 25 box 46 x 80 x 40
- 26 sliding door 43 x 38 x 20
- 27 drawer A4 43 x 38 x 39.5
- 28 drawer A6 43 x 19 x 39.5



Materialien
Schienen und Rahmen aus eloxiertem
Aluminium, Tablare und Boxen aus Pulver
beschichtetem Stahlblech.

Materials
Rail and frame: anodized aluminium,
shelves: powder coated steel sheet.

Matériaux
Rail et cadre en aluminium anodisé,
étagères en tôle thermolaquée.



o+c system





1



2



3

o + c system, gefertigt aus hochwertigen Bestandteilen für Anwender, die Flexibilität, Funktionalität, Mobilität und Qualität schätzen.

o + c system, made of high quality material for a flexible and functional use.

o + c system, pour les utilisateurs qui apprécient la fonctionnalité et l'astucieuse technique d'un produit de haute qualité.

- 1 o + c system, rail, alu | white
- 2 o + c system, double, alu | white
- 3 o + c system, detail rail | whiteboard



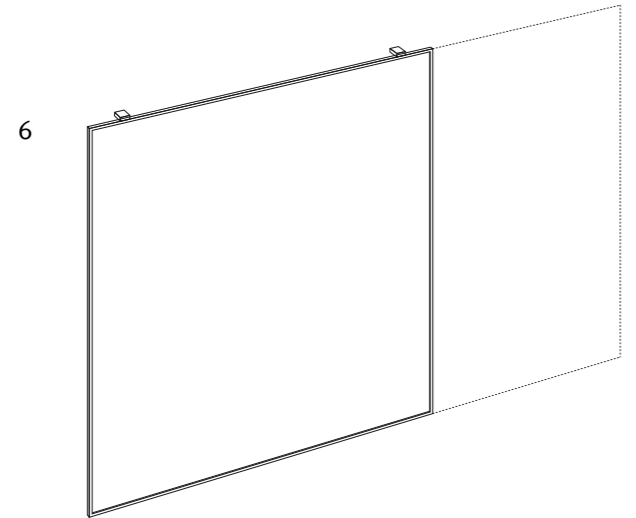
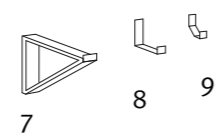
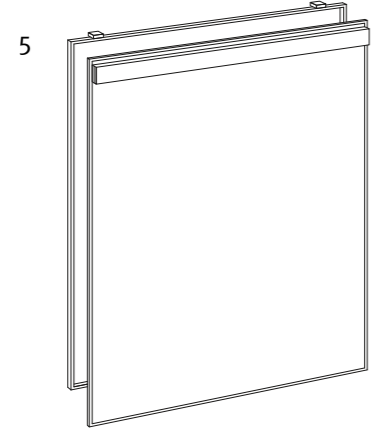
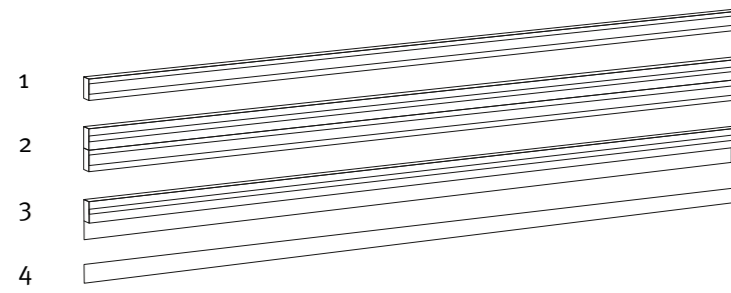

- 1 o + c system, rail 200 x 4.6 x 1.5 | 300 x 4.6 x 1.5
- 2 o + c system, double rail 200 x 7.8 x 1.5 | 300 x 7.8 x 1.5
- 3 o + c system, magnetized strip 200 x 4.0 x 0.1 | 300 x 4.0 x 0.1
- 4 rail for magnets 200 x 4.5 x 0.5 | 300 x 4.5 x 0.5
- 5 o + c system, flip-chart 78 x 108
- 6 o + c system, whiteboard 90 x 120 | 120 x 120 | 150 x 120 | 200 x 120
- 7 o + c system, screen holder 17 x 40
- 8 o + c system, coat hooks 19 x 20
- 9 o + c system, coat hooks 8 x 12

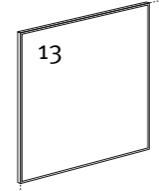
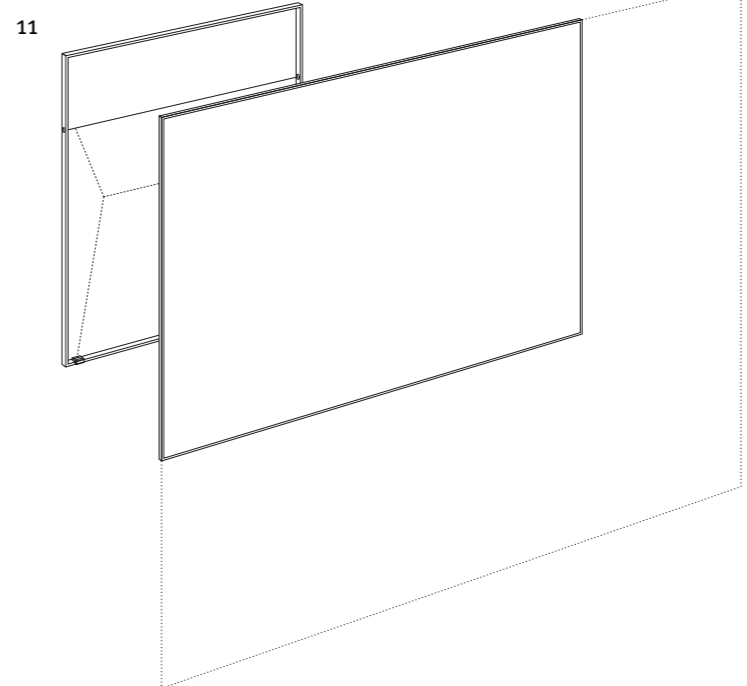
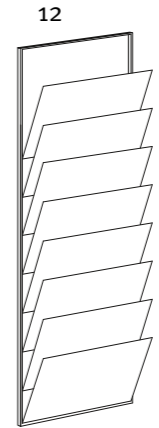
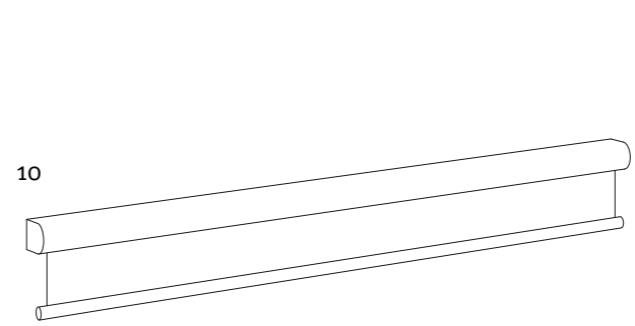

- 10 o + c system, screens 160 x 160 | 183 x 180 | 195 x 200 | 220 x 220
244 x 240 | 280 x 215
- 11 o + c system, projection boards 130 x 130 | 150 x 150 | 155 x 116 | 160 x 120 |
175 x 175 | 200 x 150 | 200 x 200 | 240 x 150
- 12 o + c system, register
- 13 o + c system, whiteboards 90 x 120 | 120 x 120 | 150 x 120 | 200 x 120
steel enamelled
fabrics
chalk
cork
adhesive

Decor Strips

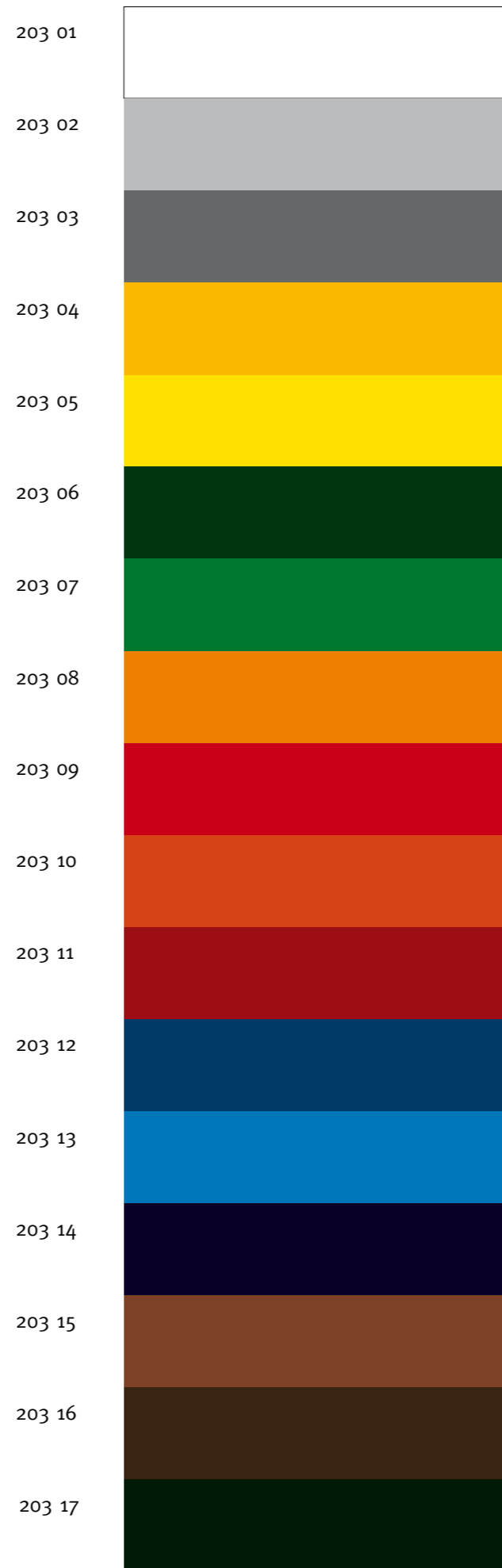

Color Code, Boards



natural cork



linen

